



8.1 - KITS

BARRA DE REFUERZO Y PINZAS PARA FIJOS

TUBO REDONDO AISI-304 Vidrio 6/8/10 mm

BARRA VIDRIO - PARED 90°

Tubo Ø 20 mm
Distancia: 250 mm

Acabados:

Inox brillo	1925 IB
Inox mate	1925 IM

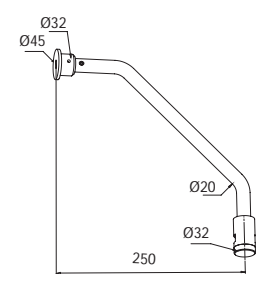

3030

BARRA VIDRIO - PARED

Tubo Ø 20 mm
Longitud: 1200 mm

Acabados:

Inox brillo	1925.2 IB
Inox mate	1925.2 IM

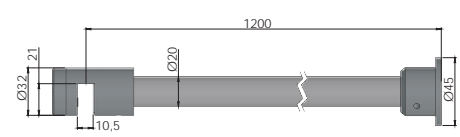
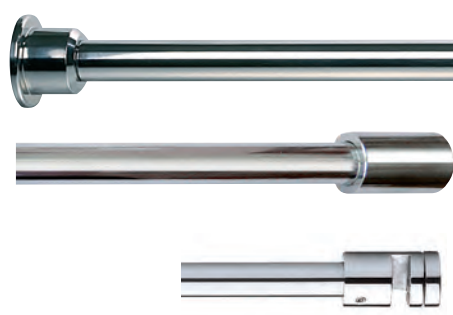

3031

BARRA VIDRIO - PARED EXTREMO ORIENTABLE

La barra se instala por encima del canto superior del vidrio, de modo que se libera espacio para el giro de la puerta hacia el interior.

Tubo Ø 20 mm
Longitud: 1200 mm

Acabados:

Inox brillo	1925.10 IB
Inox mate	1925.10 IM

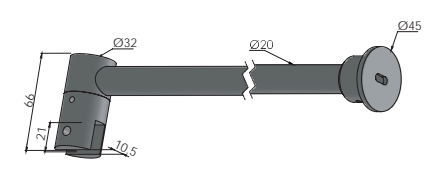

3051

BARRA TECHO - VIDRIO

Tubo Ø 20 mm
Longitud: 1200 mm

Acabados:

Inox brillo	1925.4 IB
Inox mate	1925.4 IM

Longitud: 500 mm

Acabados:

Inox brillo	1925.19 IB
Inox mate	1925.19 IM

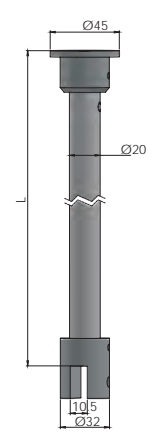

3032
3032S

BARRA EXTENSIBLE VIDRIO/PARED

Tubo Ø 25/20 mm
Longitud: 640/1080 mm

Acabados:

Inox brillo	1925.12 IB
Inox mate	1925.12 IM

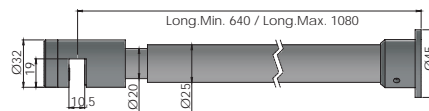
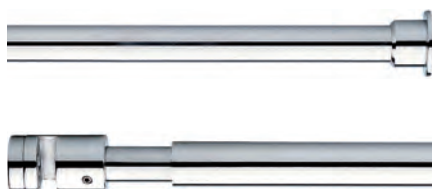

3035

BARRA ARTICULADA VIDRIO - PARED 90°

Tubo Ø 18 mm
Distancia: 250 mm

Acabados:

Inox brillo	1925.17 IB
Inox mate	1925.17 IM

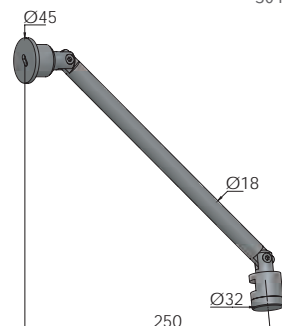

3040

LIGHT

AISI-304

Vidrio 8/10 mm

BARRA VIDRIO - PARED 90°

Tubo Ø 15 mm
Distancia: 250 mm

Acabados:

Inox brillo	1925.30 IB
Inox mate	1925.30 IM

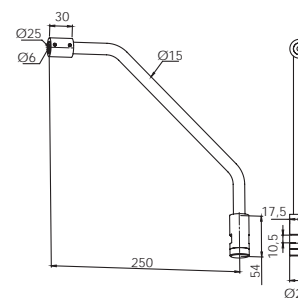

3030L

BARRA VIDRIO - PARED

Tubo Ø 15 mm
Longitud: 1200 mm

Acabados:

Inox brillo	1925.32 IB
Inox mate	1925.32 IM

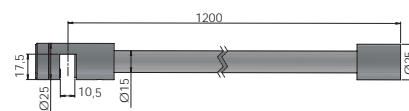

3035L

BARRA TECHO - VIDRIO

Tubo Ø 15 mm
Longitud: 500 mm

Acabados:

Inox brillo	1925.34 IB
Inox mate	1925.34 IM

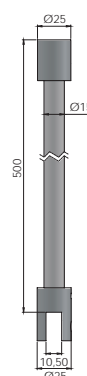

3032SL